

Ø SEGÚN GRIFO  
Ø ACCORDING TO TAP

Ø 22 mm

COTAS DE LAS TOMAS DE RED Y  
DESAGÜE PARA CONEXIONES OCULTAS  
CON INSTALACIÓN DE GRIFO  
SOBRE LAVABO/  
MAINS AND DRAIN  
SPECIFIED LAYOUT  
WHEN HAVING  
CONCEALED  
CONNECTIONS FOR  
TAP MOUNTED  
ON WASH BASIN

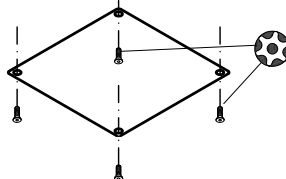
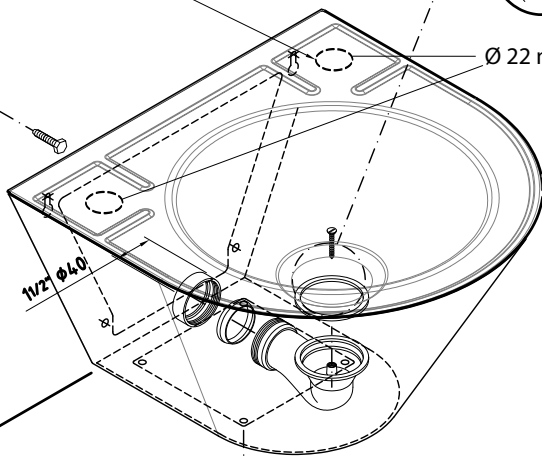

850