

HORIZONTAL BABY CHANGING STATIONS

Installation, Maintenance and Operation

OWNER'S MANUAL

ASI AMERICAN SPECIALTIES, INC.
441 Saw Mill River Road, Yonkers, NY 10701 (914) 476-9000
www.americanspecialties.com

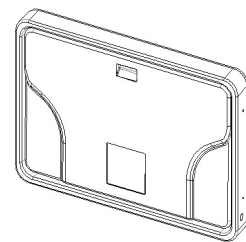
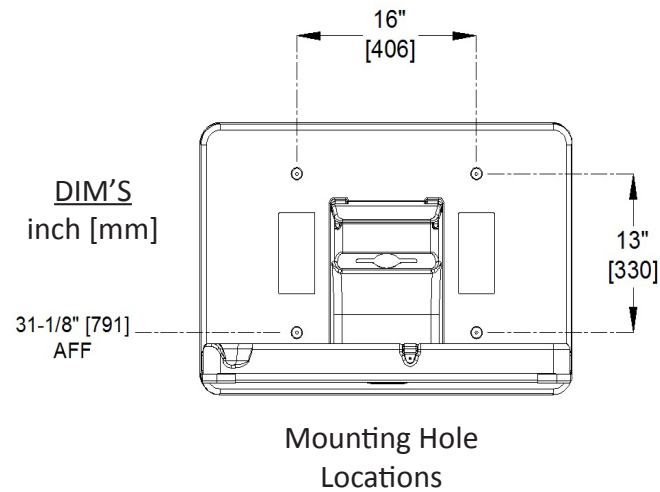

Closed

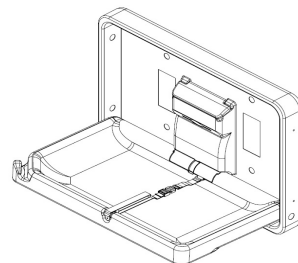

Open

9014
Surface Mounted

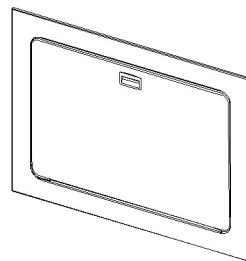

Closed

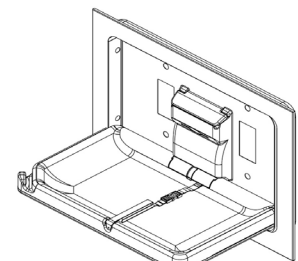

Open

9018
S.S. Recessed

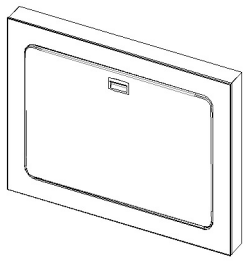

Closed

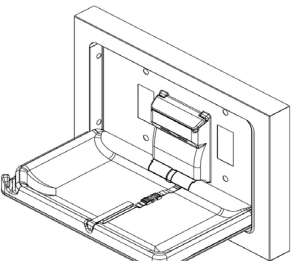

Open

9018-9
S.S. Surface Mounted

INSTALLATION

GENERAL

- A qualified installer should install the Baby Changing Station. The Baby Changing Station can support a load of up to 300 lbs (136.1 kg) including baby, any items hung on bag hooks and any leaning weight of attendant, and it is intended for use with a child of no more than 50 lbs (22.7 kg) and age up to 3.5 years.
- Appropriate wall mounting is critical to the safe use of this product. The Facility Manager is responsible for adequate supporting strength.
- Model 9014 unit weight is 19 lbs (8.6 kg). Model 9018 unit weight is 26lbs (11.8 kg). Model 9018-9 unit weight is 27 lbs (12.2 kg).
- The wall and attachment method should be sturdy enough to support more than the maximum combined load of unit weight and user-applied weight. Ensure that the Installer utilizes adequate screws and wall anchors to suit wall conditions for wall mounted changing units.
- This product complies with ANSI Z535.1, Z535.3, Z535.4, ASTM F-2285-04 and BS EN 12221-1:2008 & BS EN 12221-2:2008.
- Read this complete Owner's Manual before beginning installation.

The manufacturer and distributors of this Baby Changing Station will not be liable in any way or responsible in any manner for units that have been improperly installed.

PRIOR TO INSTALLATION

- Inspect the carton for visible damage and report any product damage or tampering immediately.
- Verify that all items are included.

Carton Contents

- 1 Baby Changing Station, protective plastic bag wrapped
- 1 Owner's Manual
- 1 Product Data Sheet
- 1 Hardware bag, containing the following:
 - Ø1/4"-20 x 2-1/2" machine screws, Qty. 4
 - Ø1/4" x 2-1/2" [Ø6 x 64] wood screws, Qty. 4
 - Ø1/4" [Ø6] Washers, Qty. 4
 - Ø1/4"-20 Toggler® Toggle Anchors, Qty. 4
 - Hole plug caps, Qty. 8

- Locate the Baby Changing Station in an area where it will not obstruct walkways or doors. Allow sufficient space in front of the unit to provide appropriate access for all approaches.
- For compliance with 2010 ADA Accessibility Standards, install unit so that top edge of changing table is 30-1/4" [768] above finished floor (AFF). This will allow 27" [686] clearance under bed.
- For a table height of 30-1/4" [768] AFF the lower mounts should be 31-1/8" [791] AFF.

FOR WOOD FRAMING

- Use 1/4" x 2-1/2" [Ø6 x 64] pan head wood screws with washers through rear wall into adequate blocking at rear wall mounting points (4).
- Shim to level and tighten all screws.

FOR METAL FRAMING

- Provide welded, wired, riveted, or screwed metal blocking to receive all mounting bolts.
- Drill Ø1/2" [Ø13] hole into hollow wall metal blocking at four (4) rear wall mounting points.
- Install Toggler® BC anchors (provided) into wall at rear wall mounting points.
- Use Ø1/4"-20 x 2-1/2" pan head machine screws with washer (supplied) into Toggler® BC anchors (supplied, installed first) and tighten securely.
- Alternatively, use №12 x 2-1/2" [Ø5.5 x 64] pan head self-threading screws (not supplied) into side framing.
- Shim to level and tighten all screws.

FOR CERAMIC TILE FACE HOLLOW WALLS

- When mounting the unit over ceramic tile you will need to drill clearance holes through the tile only with masonry bits. Use a large enough bit to provide clearance for screws or Toggler® Toggle Anchors. Follow the appropriate instructions above based on the stud framing behind the ceramic tile.

TESTING AND FINAL ASSEMBLY

- Open and close the unit several times to check for smooth operation.
- Install the 8 grey snap-in hole plug caps over the rear and side mounting holes.
- Clean all exposed surfaces of the baby changing station and work area. Refer to the product care and maintenance bulletin on the website if required.
- If the installation instructions have been followed correctly, the baby changing station is now safe and ready to use.

MAINTENANCE

- Ensure that the towel compartment is always adequately stocked.
- Thoroughly clean the unit daily either with warm water and mild anti-bacterial detergent dampened cleaning cloths, followed by a rinse with clean water dampened clean cloth and dry, or with commercial spray disinfectant cleaning products and clean soft cloths. **DO NOT SOAK OR HOSE DOWN UNIT!**
- Do not use any abrasive cleaning agents. Refer to Product Care & Maintenance bulletin available on website.
- Periodically inspect the unit to ensure that it remains securely attached to the wall, and that the integrity of the unit and the wall mounting has not been affected by vandalism or abnormal wear.
- Regularly check the safety belt to ensure safe operation. Make sure the screw mountings remain tight. Make sure the latch securely locks together when clasped.

OPERATION OF TOWEL COMPARTMENT

- The compartment door is hinged at the back and retained by the hinge pivots.
- When closing, apply downward pressure with fingertips to top edge of door. When closed, the door should be snug.
- To open, apply upward pressure in cutout finger placement area. Door should open with ease.

Towel Loading:

Multi-Fold Towels (CID A-A-696A, Type II, Size 2) will fit in the towel dispenser compartment.

- Load compartment with towel leading edge on stack bottom facing towards the floor.
- Grasp leading edge of towel with thumb and index finger through dispenser slot on bottom of compartment and pull first fold to verify proper feeding.
- Press closed compartment door.

OPERATION

USE OF BAG HOOKS

Hanging personal belongings (e.g. baby supplies, bags, backpacks, shopping bags) adds to the weight carried by the baby table. The unit can support a load up to 300 lbs (136.1 kg). Use caution and good judgement. A good guideline is to not hang more than 30 lbs (13.6 kg) total weight on the bag hooks.

WARNING! Excessive weight beyond this limit may cause a hazardous unstable condition to exist. Parcels or accessory items, or both, placed on the baby changing table may cause the unit to become unstable.

USE OF TABLE EDGE FOR USER SUPPORT

Transfer of partial adult weight (e.g. leaning on, slouching against, fall & grab) contributes to load carried by the Baby Table. The unit can support up to 300 lbs (136.1 kg). Use caution and good judgement. A good guideline is to not add more than 30 lbs (13.6 kg) total weight to front edge of table.

WARNING! Excessive weight beyond this limit may cause a hazardous unstable condition to exist. Transfer of adult attendant weight to the baby changing table may cause the unit to become unstable.

USE OF CHILD PROTECTION SAFETY STRAP

WARNING! Avoid serious injury from falling or sliding out. Always use restraint system provided on unit. Never leave the child on the bed unattended. Secure child in place with the child protection safety strap by sliding one end of buckle within other side of buckle to lock it completely into place. Adjust strap to make sure safety strap is snug against the child. Tighten or loosen the strap by pulling the strap inside the buckle itself. To unbuckle the strap, simply clasp the inner buckle inward to release it from its current state within the outside fitting.

GENERAL WARNINGS AND CAUTIONS

WARNING! NEVER leave child unattended on the bed.

CAUTION: Be aware of the risk of open fire and other sources of strong heat, such as electric heaters or gas heaters or heat lamps in the near vicinity of the changing unit.

